

Equipment Required

- ULTRA™ Charged Particle Detector model BU-014-050-100
- 142A Preamplifier
- 4001A/4002D NIM Bin and Power Supply
- 575A Spectroscopy Amplifier
- 807 Vacuum Chamber
- 428 Detector Bias Supply
- 480 Pulser
- Easy-MCA-8K including a USB cable and MAESTRO-32 software (other ORTEC MCAs may be substituted)
- Cables and Connectors
 - C-36-12 RG-59A/U 75 Ω Coaxial Cable with SHV Plugs, 12-ft (3.7-m) length
 - C-24-1/2 RG-62A/U 93 Ω Coaxial Cable with BNC Plugs, 0.5-ft. (15-cm) length
 - Two C-24-4 RG-62A/U 93 Ω Coaxial Cables with BNC Plugs, 4-ft. (1.2-m) length
 - Two C-24-12 RG-62A/U 93 Ω Coaxial Cables with BNC Plugs, 12-ft (3.7-m) length
 - C-29 BNC Tee Connector
- ALPHA-PPS-115 Portable Vacuum Pump Station
- PC-1 Personal Computer with USB port and Windows operating system
- TDS3032C Oscilloscope with bandwidth ≥ 150 MHz
- AF-210-A1 consisting of 1 μCi of ^{210}Po .
- 01865-AB 2.5-micron Mylar 3" X 300'
- 01866-AB 3.6-micron Mylar 3" X 300'
- 01867-AB 6.0-micron Mylar 3" X 300'
- S-PK-100 incorporating 100 slide mounting frames with mounting kit (plastic frames for 35-mm photographic film); used to mount the Mylar film in thicknesses from 2.5 to 25 microns in increments of 2.5 or 3.6 microns.
- Small, flat-blade screwdriver for tuning screwdriver-adjustable controls
- Access to a suitable printer for printing/plotting spectra acquired with MAESTRO-32.

Purpose

In this experiment the principle concern will be the rate of energy loss, dE/dx , and the range of an alpha particle as it passes through matter. The two experiments involve alpha particles passing through Mylar film and through a gas. This experiment requires the procedures developed in Experiment 4. Consequently, Experiment 4 is a prerequisite.

Relevant Information

For the purpose of studying how nuclear particles lose energy in various materials, the types of radiation can be separated into five categories according to how they interact with the material: 1) fast electrons, 2) heavy charged particles, 3) massive nuclei, and 4) neutrons. Heavy charged particles include the nuclei from the various isotopes of hydrogen and helium. For hydrogen isotopes, the ions are known as protons ($^1\text{H}^+$), deuterons ($^2\text{H}^+$), or tritons ($^3\text{H}^+$). For helium, the two ions are $^3\text{He}^{++}$ or alpha particles ($^4\text{He}^{++}$). Those heavy charged particles all tend to lose energy in a similar fashion in materials. Ionized nuclei that have a much higher mass than helium have similar interaction principles, but suffer complications from size and mass that place them in a separate class. Compared to heavy charged particles, fast electrons (or beta particles) travel much further in materials, and tend to spread out in random directions. Because they have no charge, neutrons interact in materials by causing nuclear reactions, or by billiard-ball collisions with protons in the material.

Because alpha particles are readily available from natural radioactive sources, they provide a convenient means of studying the interaction of heavy particles with materials. The alpha particle is identical with a doubly-ionized helium atom and consists of 2 protons and 2 neutrons, all tightly bound together. Alpha particles emitted by natural sources typically have energies in the range of 3 to

Experiment 5

Energy Loss with Heavy Charged Particles (Alphas)

8 MeV. The alpha is a relatively massive nuclear particle compared with the electron (~8000 times the mass of the electron). When an alpha particle goes through matter it loses energy primarily by ionization and excitation of atoms in the material. Because the alpha particle is much more massive than the atomic electrons with which it is interacting, it travels through matter in a straight line. The energy required to strip an electron from a gas atom typically lies between 25 and 40 eV. For air, the accepted average ionization potential is 32.5 eV. Therefore, the number of ion pairs that are theoretically possible can be easily calculated. The average ionization potential, I_{av} , has been determined for a variety of materials (ref. 12).

Specific ionization is defined as the number of electron-ion pairs produced per unit path length. Specific ionization is energy dependent, because the energy of a particle affects its rate of travel through the material being ionized. Lower energy alpha particles spend more time per unit of path length than do higher energy particles. Consequently, specific ionization increases as the alpha particle loses energy and slows down. Fig. 5.1 is a typical Bragg curve showing specific ionization for alpha particles in a generic material. Past the maximum specific ionization near the end of the path, the specific ionization drops, as the alpha particle picks up electrons from the material.

Another parameter of vital interest is the incremental energy loss over a small increment of distance. This differential energy loss, dE/dx , is known as the stopping power for the alpha particle of energy E in a specified material. The traditional Bethe formula (ref. 3 and 11) expressing the stopping power in ergs/cm for a material composed of a single, pure element is:

$$-\frac{dE}{dx} = \frac{4\pi e^4 z^2}{m_0 v^2} NB \quad (1a)$$

Where

$$B = Z \left[\ln \left(\frac{2m_0 v^2}{I_{av}} \right) - \ln \left(1 - \frac{v^2}{c^2} \right) - \frac{v^2}{c^2} \right] \quad (1b)$$

where

z = the atomic number of the incident particle,

e = electronic charge (esu),

m_0 = rest mass of an electron (g),

v = the velocity of the charged particle (cm/s)

c = velocity of light (cm/s),

N = the number of atoms per cm^3 in the absorber, so that NZ is number of electrons per unit volume of absorber

I_{av} = mean ionization potential of the target (ergs),

E = energy of the incident particle (ergs).

For alpha particles having an energy <10 MeV, the velocity, v , is less than 2.3% of the speed of light. Consequently, the v^2/c^2 terms in equation (1b) are negligible, and can be ignored. Equation (1) is a seemingly simple equation that identifies the dependence of the stopping power on the charge and velocity of the charged particle, and on the atomic density and charge per atom in the absorber. The mean ionization potential, I_{av} , bears a theoretical relationship to the atoms in the absorber. But, because it is so difficult to calculate, it is generally considered a parameter that must be adjusted to fit experimental data.

Testing the simple Bethe formula against experimental measurements shows that there are many second order effects that must be calculated and accounted for. The result is complicated, and requires a computer program to calculate the theoretical curve. Even those computer models must be fitted to experimental data at low energies. Figure 5.2 shows a calculation of the stopping power for alpha particles in Mylar (Polyethylene Terephthalate) films that has been fitted to experimental data (ref. 12). From Fig. 5.2, it can be noted that dE/dx varies slowly with energy for energies above 2 MeV.

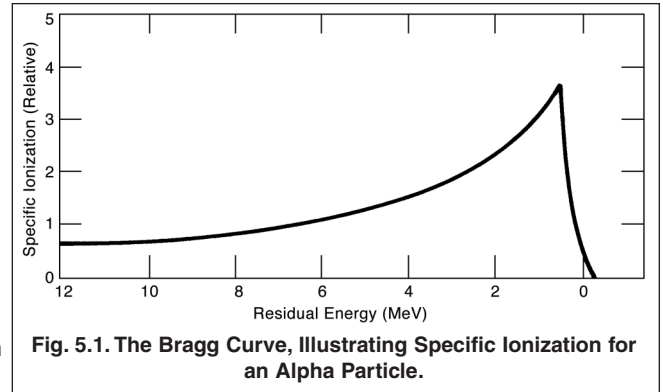

Fig. 5.1. The Bragg Curve, Illustrating Specific Ionization for an Alpha Particle.

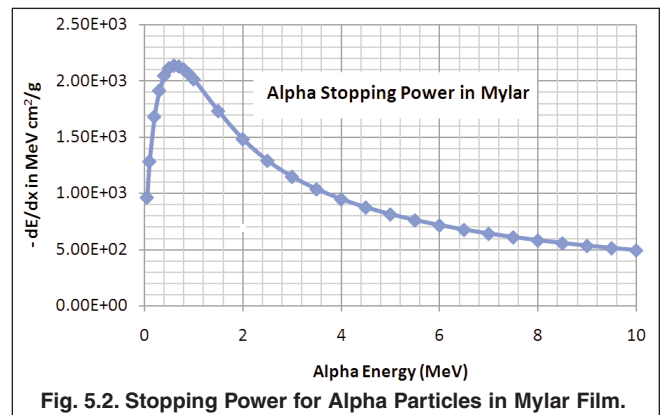

Fig. 5.2. Stopping Power for Alpha Particles in Mylar Film.

Experiment 5 Energy Loss with Heavy Charged Particles (Alphas)

The range of an alpha particle can be found by rearranging and integrating Equation (1) from E_0 to zero, where E_0 is the initial energy of the alpha. Fig. 5.3 is an example of the resulting range versus energy graph. Note in Fig. 5.3 that the range is expressed in g/cm^2 . Expressing the range in terms of weight per unit area, instead of distance, has the benefit of allowing the curves for different absorber materials to be plotted on a more compressed vertical scale.

The tabular data producing Figures 5.2 and 5.3 is listed in Table 5.1. Reference 12 is an excellent source of tabulated data for Range and Stopping Power in a variety of commonly encountered materials. Table 5.1 is a compressed listing of the data from the ASTAR program offered by ref. 12.

Table 5.1 Stopping Power and Range for Alpha Particles in Mylar

Alpha Energy E_0 (MeV)	$-dE/dx$ (MeV cm^2/g)	Range (g/cm^2)
5.00E-02	9.64E+02	7.69E-05
1.00E-01	1.29E+03	1.21E-04
2.00E-01	1.68E+03	1.88E-04
3.00E-01	1.91E+03	2.44E-04
4.00E-01	2.05E+03	2.94E-04
5.00E-01	2.11E+03	3.42E-04
6.00E-01	2.14E+03	3.89E-04
7.00E-01	2.13E+03	4.36E-04
8.00E-01	2.10E+03	4.83E-04
9.00E-01	2.06E+03	5.31E-04
1.00E+00	2.02E+03	5.80E-04
1.50E+00	1.73E+03	8.47E-04
2.00E+00	1.48E+03	1.16E-03
2.50E+00	1.29E+03	1.52E-03
3.00E+00	1.15E+03	1.93E-03
3.50E+00	1.04E+03	2.39E-03
4.00E+00	9.49E+02	2.90E-03
4.50E+00	8.76E+02	3.45E-03
5.00E+00	8.14E+02	4.04E-03
5.50E+00	7.62E+02	4.67E-03
6.00E+00	7.17E+02	5.35E-03
6.50E+00	6.77E+02	6.07E-03
7.00E+00	6.42E+02	6.83E-03
7.50E+00	6.11E+02	7.62E-03
8.00E+00	5.83E+02	8.46E-03
8.50E+00	5.58E+02	9.34E-03
9.00E+00	5.35E+02	1.03E-02
9.50E+00	5.14E+02	1.12E-02
1.00E+01	4.95E+02	1.22E-02

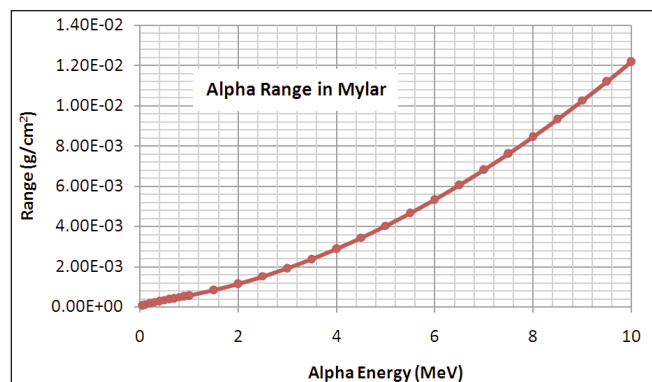

Fig. 5.3. The Range Versus Energy Curve for Alpha Particles in Mylar Film.

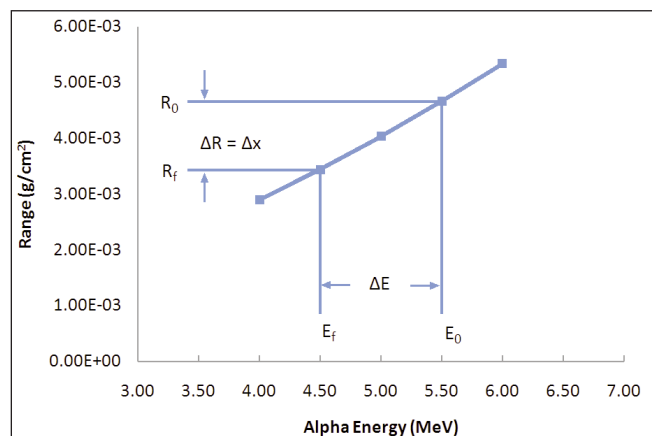

Fig. 5.4. Deriving the Energy Loss, ΔE , from the Material Thickness, Δx , using a Range-Energy Graph.

Once the theoretical range-energy curve has been plotted, as in Figure 5.3, the energy loss, ΔE , for a given film or foil thickness, Δx , can be predicted for the initial alpha-particle energy, E_0 . The principle is illustrated in Figure 5.4, which shows a small section of a range-energy curve. The original energy of the alpha particle, E_0 , is used to determine the value R_0 from the curve. The thickness of the foil or film, Δx (in units of weight per unit area), is subtracted from R_0 to find R_f . In other words, $\Delta R = \Delta x$. The point on the curve determined by R_f is used to find the corresponding value, E_f , the energy with which the alpha particle exits the film. Subsequently, $\Delta E = E_0 - E_f$ predicts the energy loss as the alpha particle travels through the foil (film) of thickness, Δx .

Table 5.2 tabulates some range-energy information for copper, nickel, gold, and helium. Traditionally, copper, nickel and gold foils have been used to demonstrate range versus energy. However, these metal films are extremely thin. They are difficult to fabricate, and are easily damaged in handling. Consequently, this experiment employs readily available and rugged Mylar films.

Experiment 5

Energy Loss with Heavy Charged Particles (Alphas)

Alpha Sources

CAUTION: Alpha sources offer a potential contamination problem. Never touch the face of a source with your fingers. Most alpha sources are electrodeposited onto platinum disks. The actual radioactive source is usually a spot ~1 mm diameter deposited in the geometrical center of the disk. If you look carefully, you may be able to see the deposited spot. **ALWAYS handle an alpha source by the edge of the mounting disk.**

The 1- μCi ^{210}Po alpha source specified for this experiment has the advantage of emitting only one alpha energy (5.304 MeV). When initially purchased, it should yield a counting rate of approximately 90 counts/second with the detector and source-to-detector spacing designated in this experiment. But, its short half life (138 days) implies that it will have to be replaced each year. At the laboratory manager's discretion, an ^{241}Am source (432 year half life) could be substituted to obviate the frequent source purchases. The ^{241}Am source has the drawback that it emits three fairly closely spaced alpha energies (see Experiment 4). Although, it still should be possible to utilize the dominant 5.486 MeV peak for the energy loss measurement. The ^{241}Am alternative will make it difficult to use the data in Table 5.4 in Experiment 5.2.

It is advisable to revisit the information in Experiment 4 on the care and handling of radioactive alpha sources.

Table 5.2. Range-Energy Values for Alpha Particles in Various Absorbers (data taken from ref. 10)

E_0 (MeV)	Ranges (mg/cm ²)			
	Copper	Nickel	Gold	Helium
0.25	0.79	0.74	1.31	0.181
0.50	1.09	1.02	1.90	0.245
0.75	1.38	1.29	2.50	0.316
1.00	1.69	1.58	3.12	0.399
1.25	2.01	1.88	3.79	0.490
1.50	2.36	2.21	4.47	0.601
2.00	3.11	2.91	5.97	0.850
2.50	3.93	3.68	7.59	1.14
3.00	4.82	4.50	9.34	1.48
3.50	5.80	5.44	11.00	1.86
4.00	6.81	6.39	13.10	2.29
4.50	7.90	7.40	15.20	2.76
5.00	9.10	8.51	17.40	3.27
5.50	10.30	9.66	19.70	3.82
6.00	11.60	10.87	22.10	4.41
7.00	14.30	13.46	27.10	5.70

EXPERIMENT 5.1. $\Delta E/\Delta x$ for Alpha Particles in Mylar Films

NOTE: The laboratory manager will supply Mylar films of various thicknesses mounted in 35 mm slide holders. The thickness of each film should be marked on the slide frames. The thickness should increase from zero to 25 μm in approximately equal increments. The thickness increments should be in the range of 2.5 to 3.6 μm , which can be achieved by stacking multiple sheets of 2.5 micron or 3.6 micron Mylar films. To convert from microns thickness to g/cm^2 , use 1.390 g/cm^3 for the density of Mylar.

Procedure

Initial Set-up

1. Connect the equipment as shown in Fig. 5.5 according to the instructions in Experiment 4.
2. Set up the controls on the instrumentation as outlined in Experiment 4, except set the amplifier gain to record the 5.48 or 5.31 MeV peak approximately in the middle of the top quadrant of the energy spectrum. Ensure that the pole-zero adjustment has been properly accomplished.
3. Calibrate the system using the ^{210}Po source and the pulse generator. Using a combination of the pulser and at least one alpha source (as outlined in Experiment 4) is the most efficient method to cover the energy range from 5.5 MeV down to 1 MeV. For measurement of energy losses, it will be most convenient if the Energy Calibration feature of MAESTRO-32 software is implemented to calibrate the horizontal scale of the multichannel analyzer. That will enable the cursor to measure the energy directly on each peak.
4. If the MAESTRO-32 energy calibration feature has not been employed, plot the calibration curve per Experiment 4.
5. Determine the FWHM resolution of the pulser and of the alpha source as in Experiment 4.

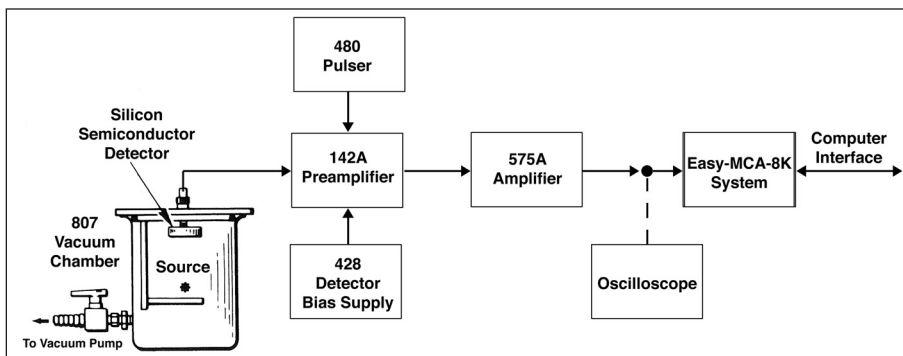

Fig. 5.5. System for the dE/dx Measurement.

Experiment 5

Energy Loss with Heavy Charged Particles (Alphas)

Energy-Loss Measurements in Mylar Films

6. Turn off the pulser, lower the detector bias voltage to zero and vent the vacuum chamber to atmospheric pressure.
7. Install the ^{210}Po source in the vacuum chamber with a source-to-detector distance of approximately 4 cm. This distance must be rigidly maintained throughout the series of energy-loss measurements. Confirm that a reliable mounting system is in place for holding the Mylar films in their plastic frames between the source and the detector, with an unrestricted line of sight for the alpha particles from the source through the Mylar film to the entire sensitive area of the detector.
8. Pump a 100 micron vacuum in the chamber, and slowly raise the detector bias to its proper voltage.
9. Clear the contents of the MCA. Collect a spectrum on the bare source long enough to obtain ~4000 counts under the alpha peak. Save this spectrum on the hard disk or a transportable medium for later reference. Record the energy of the peak position, the FWHM energy resolution and the sum of the counts in the peak.
10. Reduce the bias voltage to zero. Vent and open the vacuum chamber and place the thinnest Mylar film between the source and the detector. Do not change the source-to-detector geometry during the remainder of this experiment; both the distance and the angle of incidence must remain constant.
11. Evacuate the vacuum chamber, gradually apply the bias voltage, and accumulate a spectrum for the same time that was used in step 9. Save the spectrum for future reference. Record the Mylar film thickness, the peak position (energy), the FWHM energy resolution and the sum of the counts in the peak.
12. Repeat steps 10 and 11 for all the increments of Mylar film thickness up to at least 25 μm thickness. Fig. 5.6 shows some typical data that were obtained for alpha particles with copper foils and a ^{210}Po source. The data with the Mylar films should look similar.

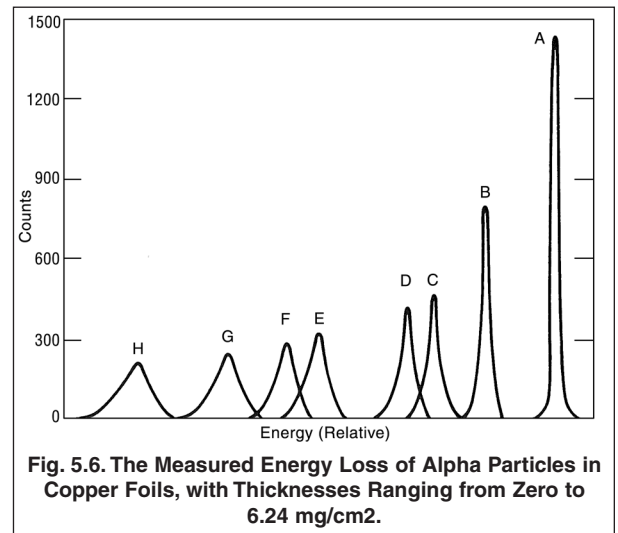

EXERCISES

- a. Using either the energy calibration curve or the MAESTRO-32 energy calibration feature, determine the energy loss, ΔE , for each increment of the film thicknesses. Note that the resolution gets worse as the total film thickness increases and the residual energy decreases.
- b. On linear graph paper, plot the range vs. energy for Mylar. From the graph and the foil thicknesses, find the measured E_f and ΔE by the method outlined in Fig. 5.4. Use those ΔE values and construct a table similar to that furnished for Fig. 5.6 (Table 5.3) for your data and fill it in. The calculated values should be obtained from Table 5.1. Numerical interpolation may be required.
- c. How do your measured energy losses compare to the predicted energy loss? Comment on the possible reasons for any discrepancies.
- d. Calculate $\Delta E/\Delta x$ for your measured data. How does that measured value compare to the values for dE/dx in Table 5.1 or Fig. 5.2, if the average energy, $(E_0 + E_f)/2$, for the incremental film thickness is used to find the theoretical value of dE/dx ?

Curve	Foil Thickness (mg/cm ²)	Alpha Particle		ΔE (MeV)	
		Energy* (MeV)	Resolution (keV)	Measured	Calculated
A	0.00	5.47	30	0.00	0.00
B	1.23	4.95	64	0.53	0.54
C	2.06	4.55	106	0.93	0.91
D	2.50	4.36	112	1.12	1.10
E	3.74	3.69	160	1.79	1.71
F	4.22	3.44	170	2.03	1.98
G	5.00	3.03	202	2.45	2.40
H	6.24	2.33	223	3.15	3.09

*After passing through copper foil.

Experiment 5

Energy Loss with Heavy Charged Particles (Alphas)

EXPERIMENT 5.2. $\Delta E/\Delta x$ of Alpha Particles in Gas (optional)

This optional experiment requires extra vacuum and gas handling equipment that is not normally supplied. The experiment can be performed if the laboratory manager provides the necessary equipment and a bottle of helium gas.

There are many advantages in using gas as an absorbing medium because the gas pressure can be varied to any desired value in order to regulate the thickness of the absorber. The pressure can be monitored by a gauge in the vacuum/supply line. The general procedure consists of placing the source ~2 cm from the detector, or closer if necessary to get good statistics within a reasonable acquisition time, pumping the full vacuum, closing off the vacuum pump, and then leaking the gas (air or helium, for example) into the chamber for the desired pressure. The number of mg/cm² of the gas can be determined by applying the Gas Law to STP (standard temperature and pressure) reference values.

Because the volume of the chamber is constant, and the gas temperature should reach equilibrium with room temperature fairly quickly, one can presume the density of the gas at pressure P is related to the density at atmospheric pressure, P_A, by

$$\rho_P = \frac{P}{P_A} \rho_A$$

Where ρ_P is the density at pressure P, and ρ_A is the density at atmospheric pressure. The density of helium at 0°C and 1 atmosphere (760 mm Hg) is 0.1785 grams/liter. That density will have to be corrected for the actual room temperature via

$$\rho_A = \rho_{A0} \frac{T_0}{T_R}$$

Where ρ_{A0} is the density at 1 atmosphere and 0°C, ρ_A is the density at room temperature T_R, and T₀ is the Kelvin temperature corresponding to 0°C, i.e., 273.15°K. The room temperature must also be converted to degrees Kelvin for equation (3). Small corrections may also be necessary for variations of barometric pressure from STP conditions at the time of the experiment, depending on whether the vacuum gage produces absolute readings or indicates differences from atmospheric pressure.

The exact distance from the surface of the source to the front surface of the detector will have to be measured to convert the gas density into mg/cm².

Helium has the advantage of being available as a pure gas. The portion of the experiment with air is hampered by room air being subject to humidity variations. Correcting for humidity (water vapor content) is too complicated for this exercise. Consequently, the measured results may vary from the theoretical values because of the uncontrolled humidity.

Procedure

- Repeat all the steps of Experiment 5.1 using helium as the absorbing medium rather than Mylar film. Take enough measurements so that your measured energy loss has at least six increments between no absorber and a maximum energy loss of 4 MeV.
- Repeat step 1 for air. Range vs. Energy values for air can be found in ref. 3 or 12. Compare your results with those shown in Table 5.4 and Fig. 5.7.

Table 5.4. Energy Loss Data for Figure 5.7.

Curve	Foil Thickness (mg/cm ²)	Alpha Particle		ΔE (MeV)	
		Energy* (MeV)	Resolution (keV)	Measured	Calculated
A	0.00	5.47	137	0.00	0.00
B	0.95	4.77	149	0.73	0.73
C	1.89	3.96	168	1.54	1.52
D	2.84	3.03	195	2.47	2.46
E	3.78	1.95	230	3.55	3.60

*After passing through air.

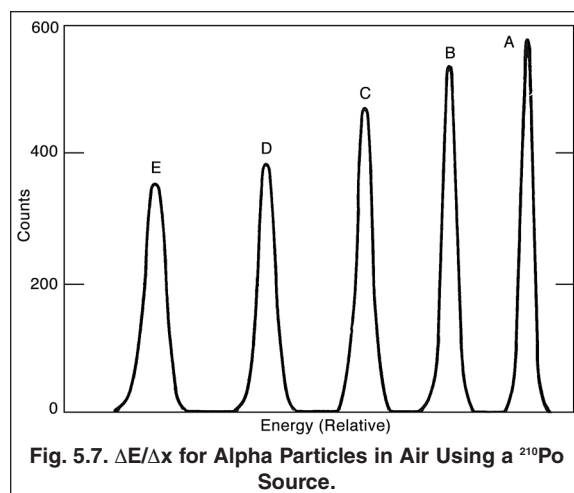

Experiment 5

Energy Loss with Heavy Charged Particles (Alphas)

References

1. L.C. Northcliffe and R. F. Schilling, Nuclear Data Tables A7, 233 (1970).
2. J. F. Ziegler, The stopping Power and Ranges of Ions in Matter, Pergammon Press, New York (1977).
3. G. F. Knoll, Radiation Detection and Measurement, John Wiley and Sons, Inc., New York (1979)
4. J. B. Marion and F. C. Young, Nuclear Reaction Analysis, John Wiley and Sons, Inc., New York (1968).
5. G. Dearnaley and D. C. Northrop, Semiconductor Counters for Nuclear Radiations, 2nd Ed., John Wiley and Sons, Inc., New York (1966).
6. J. L. Duggan, W. D. Adams, and L. S. Anthony, "Charged-Particle Detector Experiments for the Modern Physics Laboratory", Am. J. Phys. 35(7), 631 (1967).
7. D. J. Skyrme, Nucl. Instrum. Methods, 57, 61 (1967).
8. S. Matteson, E.K. L. Chau, and D. Powers, Phys. Rev. A 14, 169 (1976).
9. J. F. Janni, Calculations of Energy Loss, Range, Pathlength, Straggling, Multiple Scattering, and the Probability of Inelastic Nuclear Collisions for 0.1 to 100 MeV Protons, AFWL-TR-65-150 (AD-643837), (1966). Available from Clearinghouse for Federal Scientific and Technical Information, Springfield, Virginia.
10. C. F. Williamson, J. P. Boujot, and J. Picard, Tables of Range and Stopping Power of Chemical Elements for Charged Particles of Energy 0.5 to 500 MeV, CEQ-R-3042 (1966). Available from Clearinghouse for Federal Scientific and Technical Information, Springfield, Virginia.
11. R. D. Evans, The Atomic Nucleus, McGraw-Hill, New York (1955).
12. M.J. Berger, J.S. Coursey, M.A. Zucker and J. Chang, Stopping-Power and Range Tables for Electrons, Protons, and Helium Ions, NISTIR 4999, ASTAR Program, NIST Physics Laboratory, <http://www.nist.gov/physlab/data/star/index.cfm>.

Specifications subject to change
083010

ORTEC[®]

www.ortec-online.com

Tel. (865) 482-4411 • Fax (865) 483-0396 • ortec.info@ametek.com
801 South Illinois Ave., Oak Ridge, TN 37831-0895 U.S.A.
For International Office Locations, Visit Our Website

AMETEK[®]
ADVANCED MEASUREMENT TECHNOLOGY